

EBA OWNERS ROBLOX MANUAL

READ THIS ENTIRE MANUAL BEFORE USING



OFFROAD USE ONLY

INTRODUCTION

Thank you for purchasing this mini ATV. The proper care and maintenance that your vehicle requires is outlined in this manual. Following these instructions will ensure a long trouble-free operating life for the vehicle and your satisfaction with it.

The owner's manual corresponded to the latest model of this vehicle at the time of printing. Slight deviations resulting from continuing development and design can, however, not be completely excluded. All specifications are non-binding, we reserve the right to modify or delete technical specification, parts, design, etc... without prior notice.

SAFETY WARNING

SAFETY WARNINGS

This vehicle is NOT A TOY and should ONLY be used in closed off areas isolated from public road traffic.

Never permit children under the age of 12 to operate this ATV.

Adult's supervision is required for children under age 16.

WARNING:

Riding a mini ATV can be a hazardous activity. Certain conditions may cause the equipment to fail without fault of the manufacturer. Like other electric vehicles, the Mini ATV can and is intended to move, and it is therefore possible to lose control, fall off and/or get into dangerous situations that no amount of care, instruction or expertise can eliminate. If such things occur you can be seriously injured or die, even when using safety equipment and other precautions. **RIDE AT YOUR OWN RISK AND USE COMMON SENSE.**

This manual contains many warnings and cautions concerning the consequences of failing to maintain, inspect or properly use your mini ATV. Because any incident can result in serious injury or even death, we do not repeat the warning of possible serious injury or death each time such a possibility is mentioned.

APPROPRIATE RIDER USE AND PARENTAL SUPERVISION

This manual contains important safety information and usage tips to help you and your child operate and handle the mini ATV. Carefully read the manual entirely together with your child before letting your child ride it for the first time. The manual also contains important information on servicing the vehicle.

It is your responsibility to review the manual and make sure that all riders understand all warnings, cautions, instructions and safety topics and assure that the riders are able to safely and responsibly use this product and protect your child from injury. We recommend that you periodically review and reinforce the information in this manual with your child, and that you inspect and maintain your children's vehicle to insure their safety. **The recommended rider age of 12 years** is only an estimate, and can be affected by the rider's size, weight or skills. Any rider unable to fit comfortably on the mini ATV should not attempt to ride it.

It is important and necessary that children receive proper training and instructions in the correct use of the vehicle before they ride it. To get training information, please contact the dealer who you purchased the vehicle from, they will be able to advise you. Do not let your child use this vehicle without proper training.

Children often underestimate or fail to recognize dangerous situations, you should make it clear to your child that they should not, under any circumstances, operate the vehicle without supervision and that your child may only drive at speeds that are appropriate to the child's riding ability and road condition.

A parent's decision to allow his or her child to ride this product should be based on the child's maturity, skill and ability to follow rules.

Keep small children younger away from the mini ATV and remember that it is intended for use only by persons who are completely comfortable and competent while operating the vehicle.

ACCEPTABLE RIDING PRACTICES AND CONDITIONS

Always check and obey any local laws or regulations which may affect the locations where the Mini ATV may be used.

PROHIBITED ITEMS

- ★ Do not touch the brakes or engine when the ATV is in use as they can become very hot.
- ★ This vehicle should use a mixture of unleaded gasoline and two cycle engine oil. The volume ratio is 25:1. Do not use any degraded fuel (which smells sour) or fuel of wrong mixture ratio. It will cause a poor start, insufficient output or damage to the engine.
- ★ Do not use 4 cycle engine oil. (it may cause the plugs to be degraded, the piston ring to seize or the muffler to be clogged)
- ★ Do not run the engine in a room or poor ventilated area. (The exhaust gas includes odorless but hazardous carbon monoxide.)
- ★ Do not put your fingers and other body parts near to the drive chain, steering system, wheels or any other moving components.
- ★ Do not store, spill or use any gasoline near a fire, stove, oven, boiler or other items which uses a pilot light or spark. (it may cause an explosion.)
- ★ Smoking is strictly prohibited while refilling the fuel
- ★ While the engine is running or while it remains hot soon after stopping, do not remove the lid of the fuel tank or refill the fuel. (Before refilling the fuel, stop the engine and cool it down for 2 minutes or more.)
- ★ If any gasoline is spilt or smelled or any danger of explosion felt, do not run the engine.
- ★ Do not ride at night or when visibility is limited.
- ★ Never carry passengers or allow more than one person at a time to ride the mini ATV
- ★ Do not check for a spark while keeping the spark plug removed.
- ★ Do not run the engine with the muffler or air cleaner cover removed.
- ★ Do not touch any hot muffler or engine part. (it may cause a burn.)
- ★ When the engine is running, do not touch any spark plug cap or high tension cord. (it may cause an electric shock and bodily harm.)
- ★ Never hitch a ride with another vehicle.
- ★ Do not ride if it is raining, snowing, over slippery surfaces, or unstable ground due to gravel, sand etc.
- ★ Never use alcohol or drugs before or while operating.
- ★ Do not ride if you weight is over 155lbs/70KG.
- ★ Your insurance policy may not provide coverage for accidents involving the use of this vehicle. Consult your insurance agent before using this vehicle.

PROPER RIDING ATTIRE

Always wear proper protective equipment such as an approved safety helmet, elbow pads and kneepads. A helmet may be legally required by local law or regulation in your area. A long-sleeved shirt, long pants and gloves are also recommended. Always wear athletic shoes, never drive barefooted or in sandals, and keep shoelaces tied and out of the way of the wheels,

motor and drive system.

**FAILER TO USE COMMON SENSE AND HEED THE ABOVE WARNINGS INCREASES THE RISK OF SERIOUS INJURY.
USE WITH CAUTION AND SERIOUS ATTENTION TO SAFE OPERATION.**

SAFETY REMINDERS

PRE-RIDE CHECKLIST

Loose Parts

Check and secure all fasteners before every ride. Make sure steering stem clamp bolts are locked properly in place. There should not be any unusual rattles or sounds from loose parts or broken components. If you are not sure, ask an experienced mechanic to check.

Brake

Check the brake for proper function. When you squeeze the lever, the brake should provide positive braking action.

Frame, Fork and Handlebars

Check for cracks or broken connections. Although broken frames are rare, it is possible for an aggressive driver to bash into a curb or wall and wreck and bend or break a frame. Get in the habit of inspecting the Frame, Fork and Handlebars regularly.

Tire Inflation

Periodically inspect the tires for excess wear, and regularly check the tire pressure and re-inflate as necessary. If you get a flat tire, the inner tube can be patched or a new tube can be purchased from an authorized repair shop.

Safety Gear

Always wear proper protective equipment such as an approved safety helmet, elbow pads and kneepads, these can generally be bought from the dealer where you purchased the Mini ATV. Always wear shoes (lace-up shoes with rubber soles), never drive barefooted or in sandals, and keep shoelaces tied and out of the way of the wheels, motor and drive system

ATTENTION

We recommend checking all tightenings after the first use. Special attention should be paid to the following parts:

- Footrest
- Engine sprockets (Racing version only)
- Shock absorber
- Engine bolts and nuts
- Rear sprocket

ECOLOGIC DRIVE

The noise and the pollution of every vehicle depend on how it is driven.

We strongly recommend you drive steadily, without strong acceleration and deceleration

During off road use, do not damage the environment, avoid noise and anything that can disturb persons and animals.

Use a sport drive only on race circuits.

HAND DRIVE CONTROLS



1. Rear brake lever
2. Front brake lever
3. Stop switch
4. Emergency kill switch
5. Accelerator lever

PRODUCT DESCRIPTION



- | | | |
|----------------------|----------------------|-------------------|
| 1. front brake lever | 2. throttle | 3. handlebar |
| 4. kill switch | 5. rear brake lever | 6. seat |
| 7. muffler | 8. rear tyre 4" | 9. chain cover |
| 10. footrest | 11. front tyre 4" | 12. front shock |
| 13. front swing arm | 14. front disk brake | 15. bumper |
| 16. plastic body | 17. wheel rim | 18. engine |
| 19. rear disk brake | 20. chain | 21. rear sprocket |
| 22. wheel fender | 23. rear shock | 24. rear axle |
| 25. disk brake cover | 26. ignition key | |



- | | | |
|----------------------|------------------------|---------------------|
| 1. front brake lever | 2. rear brake lever | 3. handlebar |
| 4. kill switch | 5. bumper | 6. front shocker |
| 7. footrest | 8. front tyre (4.10-6) | 9. front disk brake |
| 10. seat | 11. rear tyre (13*5-6) | 12. plastic body |
| 13. throttle | 14. engine | 15. front swing arm |
| 16. chain cover | 17. rear disk brake | 18. chain |
| 19. rear sprocket | 20. rear axle | 21. muffler |
| 22. tank cap | 23. ignition key | |

BEFORE YOU BEGIN

Remove contents from box. Remove the foam separators that protect the components from damage during shipping. Inspect the contents of the box for scratches in the paint, dents or kinked cables that may occur during shipping. Because the product was 85 percent assembled and packed at the factory, there should not be any problems, even if the box has a few scars or dents.

Estimated Assembly and Set-Up Time

We recommend assembly by an adult with experience in motorbike or bicycle mechanics. Allow up to 30-40 minutes for assembly.

Required Tools

Some tools may be supplied; however, we recommend the use of mechanic's grade tools. Use the supplied tools only if you have no others available.

The list of tool required is as follows

- Open end wrench 10mm / 13mm/ 17mm / 22mm
- Allen wrench 5mm / 6mm/ 8mm
- Bicycle style tire pump with pressure gauge

Assembly illustration and instruction

ASSEMBLY REAR WHEEL 4"

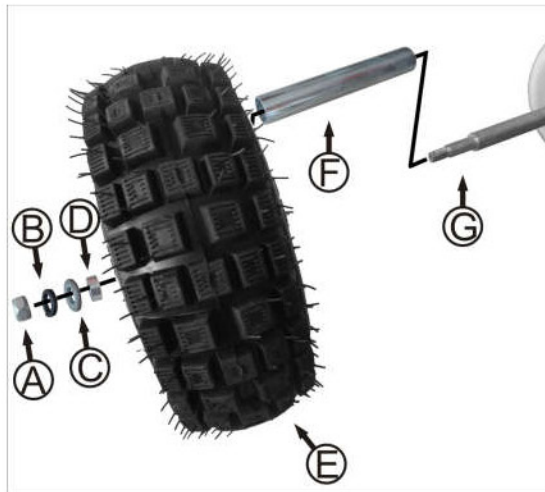

- A: Nut M10 2PCS
- B: Spring Washer $\Phi 10$ 2PCS
- C: Washer $\Phi 10$ 2PCS
- D: Bush $\Phi 22 \times 1.8 \times 139$ 1pcs (Left)
 $\Phi 22 \times 1.8 \times 139$ 1pcs(Right)
- E: Rear wheel 2PCS
- F: Sleeve $\Phi 22 \times 1.8 \times 10$ 2PCS
- G: Rear axle

1. Install the sleeve(F) to the rear axle (G).
2. Fix the rear wheel (E) through the axle (G).
3. Mount the bush(D), flat washer(C), spring washer (B) and nut(A) in sequence, then tighten the nut securely with 17mm open end wrench.

ASSEMBLY REAR WHEEL 6"

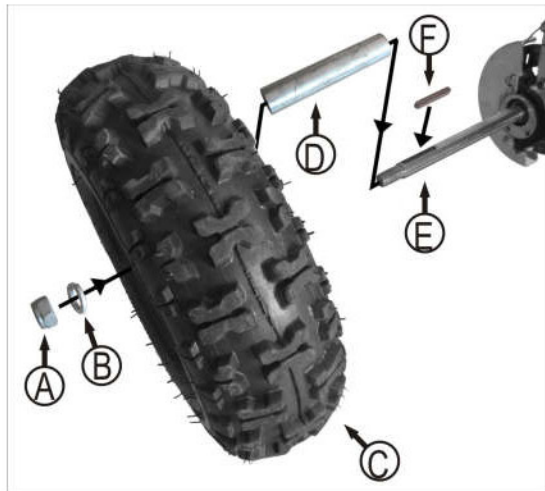

- A: Nut M14 2pcs
- B: Washer $\Phi 14$ 2pcs
- C: Rear wheel
- D: Sleeve $\Phi 22 \times 1.8 \times 112$ 2pcs
- E: Rear axle
- F: Pin 2pcs

1. Install the sleeve(D) to the rear axle (E).
2. Put the pin(F) into the groove on the axle.
3. Fix the wheel(C) through the axle.
4. Mount the spring washer (B) and then tighten the nut(A) securely with 22mm open end wrench.

ASSEMBLY REAR SHOCKER

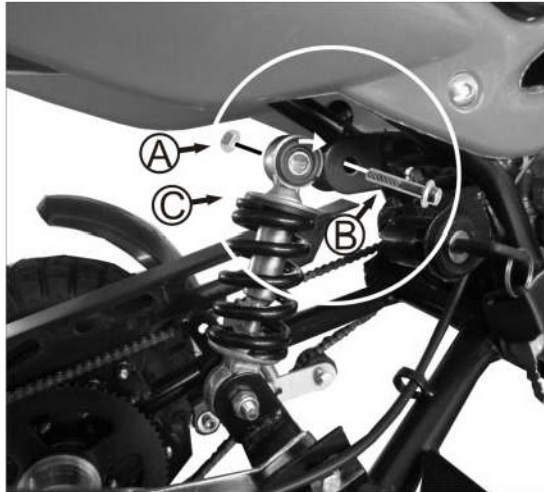

A: Nut M8 1pcs

B: Bolt M8×40 1pcs

C: Rear shock

1. Lift the frame to align the shock (C) mounting hole to the shackle joint hole.
2. Fix the bolt (B) through the shock mounting hole and shackle joint and tighten the nut (A) securely with 10mm -13mm open end wrench.

ASSEMBLY FRONT WHEEL

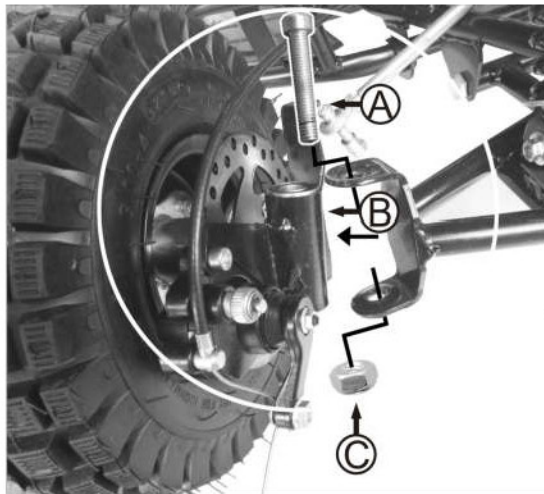

A: Bolt M10×90 2pcs

B: Wheel suspension left and right

C: Nut M10 2pcs

1. Put the front wheel suspension (B) into the front swing arm joint, align the bearing hole to the joint upper and bottom hole.
2. Mount the bolt (A) through the hole and twist the nut (C), tighten it securely with 17mm open end wrench and 8mm allen wrench.

ASSEMBLY TIE ROD

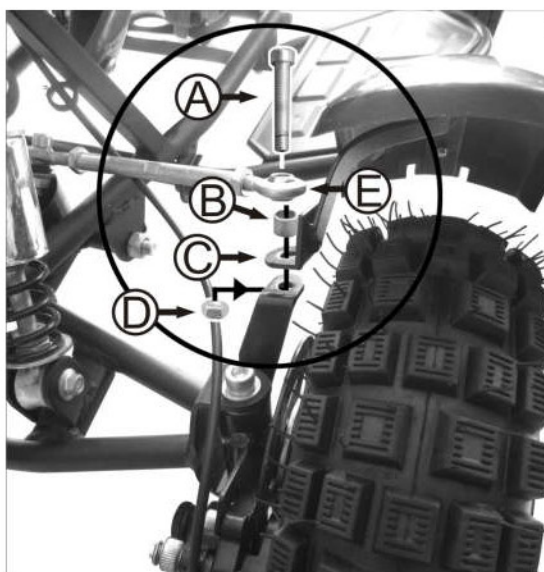

A :Bolt M8×40 2pcs

B: Bush $\Phi 10 \times 1.5 \times 10$ 2pcs

C: Bracket left and right 2pcs

D :Nut M8 2pcs

E. Tie rod left and right 2pcs

1. Align the hole of tie rod end ball (E), bush(B), bracket of mudguard(C) in sequence.
2. Mount the bolt(A) and tighten the nut (D) securely with 13mm open end wrench and 6mm allen wrench.

ASSEMBLY FRONT SHOCK

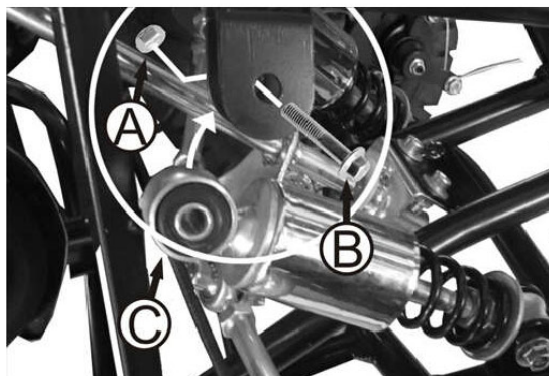

A: Nut M8 1pcs

B: Bolt M8×40 1pcs

C: Front shock

1. Lift the frame to align the shock (3) mounting hole to the shackle joint hole.
2. Fix the bolt (2) through the shock mounting hole and shackle joint and tighten the nut (1) securely with 10mm and 13mm open end wrench.

ASSEMBLY BUMPER

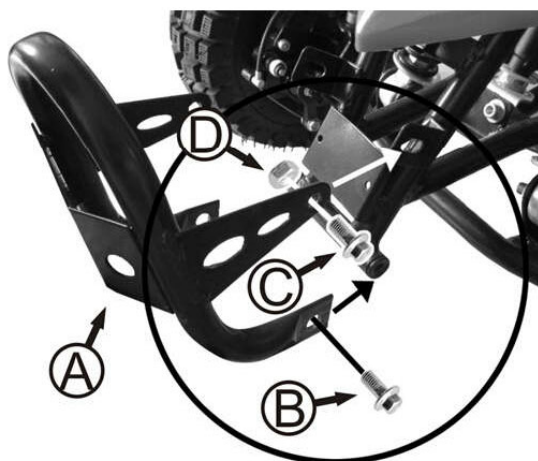

A: Bumper

B: Bolt M8×16 2pcs

C: Bolt M8×16 2pcs

D: Nut M8 4pcs

1. Align the bottom mounting hole of bumper (A) to the frame bottom joint and mount the bolt (B), DO NOT tighten the bolt to keep the bumper free to move.
2. Turn the bumper to align the upper mounting hole of the bumper to the frame upper joint, then mount the bolt (C) and twist the nut (D).
3. Tighten the bolt (B) and nut (D) securely with 10mm and 13mm open end wrench

ASSEMBLY CHAIN COVER

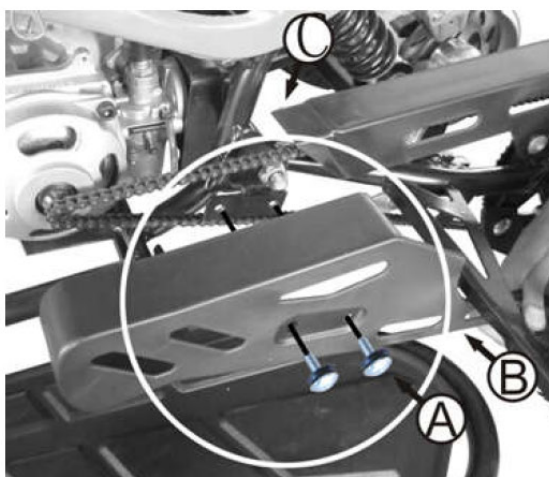

A: Bolt M6×16 2pcs

B: Front chain cover

C: Rear chain cover

1. Combine the front part of chain cover (B) with the rear part of chain cover (C) and ensure the chain is completely covered.
2. Install the 2pcs bolt (A) into the bracket and tighten it securely with allen wrench 5mm.

ASSEMBLY NUMBER BOARD

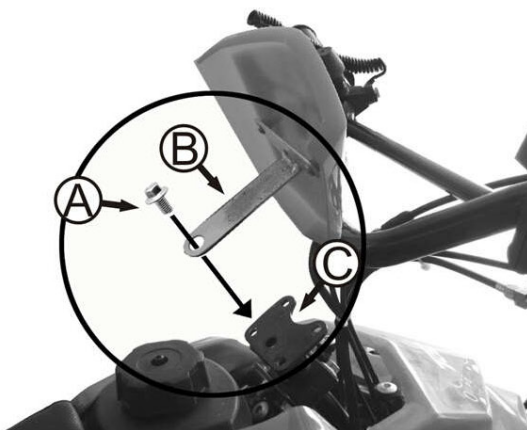

- A: Bolt M8×16 1pcs
- B: Number board bracket
- C: Steering rod plate

1. Place the bracket (B) on the steering rod plate (C) with the hole in alignment.
2. Install the bolt (A) and tighten it with 10mm open end wrench

ASSEMBLY HANDLEBAR

WARNING:

Failing to properly adjust and tighten the bolts that affix the handlebars can cause you to lose control and crash.

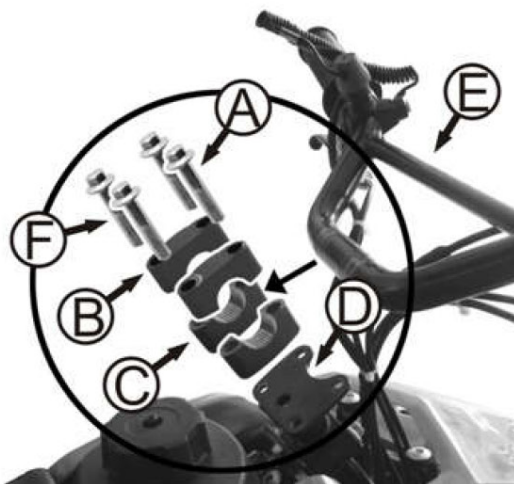

- A: Bolt M8×50 4pcs
- B: Upper Clamp
- C: Bottom Clamp
- D: Steering rod bracket
- E: Handle bar

1. Put the bottom clamp(C) on the steering rod plate(D) with screw holes in alignment, and place the handlebar (E) in the bottom clamp, then place upper clamp (B) on the handlebar and install the 4pcs bolt (A).
2. Place the handlebar in the upright and vertical position, then tighten all the bolts securely with 10mm socket spanner.

TECHNICAL SPECIFICATION SHEET

Engine type	single cylinder, 2 stroke, forced air cooling
Power output	2.0kw/7500rpm
Max torque	2.3 N.m/3600rpm
Displacement (ml)	44
Fuel	Petrol mixed with 4% 2-stroke engine oil
Compression Ratio	7.5 : 1
Transmission	automatic with centrifugal clutch
Start method	manual pull start
Optional / battery	12V 4AH (only available in mini ATV with electric starter)
Max speed (km/h)	32

Front suspension	double mechanical damper
Rear suspension	mono shock absorber
Tyre (standard 4")	front & rear 3.00-4 with 4.00 Psi operation pressure and 24 Psi Max. inflate
Tyre (optional 6")	front 4.10-6 with 7.00 Psi. operation pressure and 20 Psi. Max. inflate, rear 13.00 x 5-6 with 7.00 Psi. operation pressure and 20 Psi Max. inflate.
Brake system	front and rear disc brake with mechanical control

Inflating the Tyres

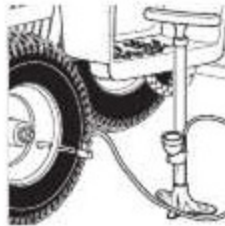

NOTE: The 6" rear tyres are inflated when shipped, but they invariably lose some pressure between the point of manufacturing and your purchase. Be sure to inflate the tyres to the correct PSI before first time use.

Please read the specification sheet to get the information of tyre pressure.

Using a bicycle-style tyre pump to inflate the tyre to the PSI indicated on the sidewall of the tyre.

Note: The pressurized air supplies found at gasoline stations are designed to inflate high-volume automobile tyres. If you decide to use such an air supply to inflate your tyres, first make sure the pressure gauge is working, then use very short bursts to inflate to the correct PSI. If you inadvertently over-inflate the tyre, release the excess pressure immediately.

Important information for use and care of tyres

Note: The tyres are the only contact surface between the vehicle and the road, the safety of various riding activity depends on the small surface of tyre in contact with the road. Therefore, it is very important to keep the tyres in good condition at all times and use the correct size and type of tyre to replace the used ones.

Guide:

Tyre assembly and disassembly

It is strongly recommended that the tyre assembly and disassembly should be done by an authorized technician with the necessary skills and training.

Tyre inflation pressure

It is very important to ensure the tyres have the correct pressure and check the tyre pressure before use. The tyre should only be inflated when it is cold.

Tyre maintenance

The tyre tread depth should be checked regularly. (Shallower tread means less grip). You must stop using the vehicle immediately if the tire is damaged, the tyre should be removed, checked carefully and repaired, if possible, or replaced in the event of damaged being detected. Tyre maintenance should be done by an authorized technician. The tyre should be replaced immediately if distortion or damage is discovered.

Tyre replacement

It is important to use the correct size and type of tyre as per our specification (see details in technical specification sheet)

Do not use used tyres if you are unsure of their previous use or are concerned about their condition.

Tyre aging

Tyre aging is unavoidable even if the tyre is not ever used or just used a few times. Tyre aging is mainly reflected in the cracked section on side of tyre and tyre tread, sometimes the tyre is distorted as well. The used and aged tyre should be checked and confirmed if it is ok to use again by an authorized technician

● Checks and maintenance before and after off-road use

In order to avoid problems connected to the operation of the vehicle, it is advisable to perform a number of checks and maintenance operations before and after use. Just a few minutes given to these procedures will save you time and money, and will make riding much safer.

Proceed as follows:

- Check pressure, general condition and thickness of trye tread.
- On cold days, warm up the engine by running it at idle speed for a few minutes before starting off.
- Wash the vehicle carefully after every off-road use.

● Fueling operations



Remove cap A counterclockwise.

The fuel tank will hold approximately 1.5 liter.

Only use green fuel mixture with 4% oil.

● Breaking in

During the first 25 hours of operation running-in, the following precautions should be used;

- Avoid travel at high speeds
- Change speed often so that the parts will break in uniformly and in a shorter time
- Avoid turning the throttle more that 3/4 of the way.

WARNING

- Change the crankcase oil after 500km.
- Always use a mixture of green grade gas and a good quality oil.
- After the first off-road use, check all of the nuts and bolts.

● Startup

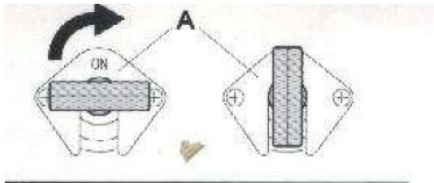

Manual hand pull

- Open fuel tank valve **A** **ON** = open
- Pull the starter as shown while slightly turning the throttle twist grip.
- Always close the fuel tank valve when the engine is off.

Note:

When the engine is cold, act on the starter by pushing down lever **B**, wait for a short and then reposition the lever to its former position.

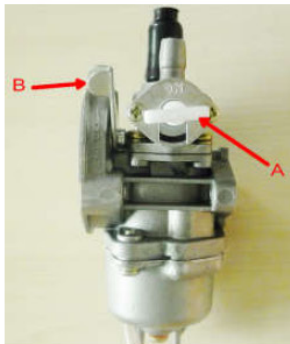

● Air filter



Air filter box **A** is fitted directly on the carburetor.

To remove the box, undo the two screws **B**.

The filter box contains filter element **C** and support **D**



Note:

If filter **C** is very dirty, wash it in soapy water and then reinsert it into its casing.

Clean the filter every time the vehicle is used cross country.

● Spark plug

Keeping the spark plug in good condition will reduce fuel consumption and increase engine performance.

To perform the check, simply slide off the electrical connection tube and unscrew the spark plug. Examine the distance between the electrodes with a feeler. This distance should be from 0.5 to 0.6 mm. If it is not, it may be corrected by bending the earth electrode.

Check as well that there are no cracks in the insulation or any corroded electrodes. If so, replace immediately.

When replacing the spark plug, screw it in by hand until it stops, then tighten with a wrench.

● Brakes

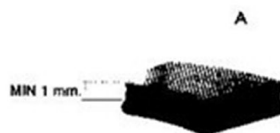
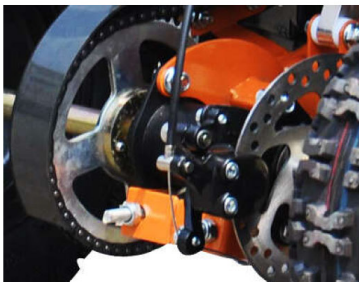

To check the wear of front and rear brake pads **A**, simply inspect the brakes calipers as shown in the figure.

The thickness of the lining on the ends of the four pads should never be less than 1mm.

Should the lining be thinner, immediately replace the brake pads.

We recommend having the brake pads replaced by an authorized dealer

● Check after cleaning

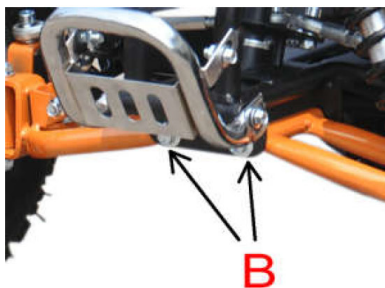
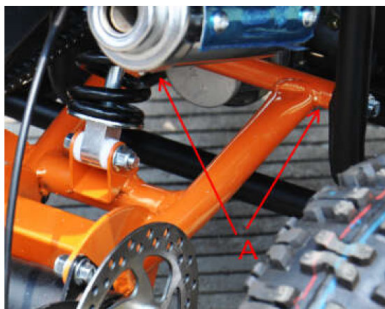

After cleaning the motorcycle, it is good practice to:

- Take off the flywheel cover and remove any dirt and water.
- Apply the lubricant above articulation points **A** and **B** on the rear and front swing arm.
- Carefully clean and dry the chain-gear-position assembly and then apply grease thoroughly in order to keep these parts in good condition as long as possible.
- Dry thoroughly any metal parts subject to corrosion, oxidation, etc.

● Adjustment

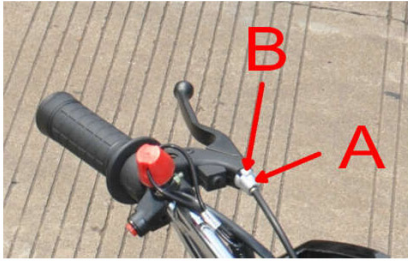

The front and rear brakes are mechanically operated disc brakes, which require periodic adjustment.

As shown in the figure, there should be 5-6 mm play.

To adjust the play, follow these steps:

-Check the play in driving position.

-If the clearance is excessive, use adjuster **A** on the brake lever to obtain the desired position.

-Tighten Locknut **B**.

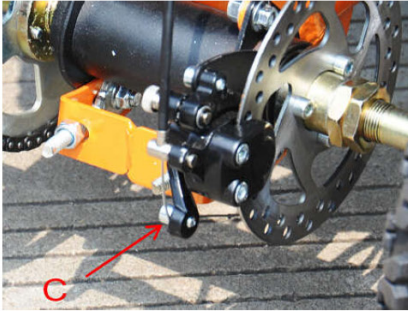

Note:

The front and rear brake calipers are equipped with an adjuster **C** that allows the braking action to be adjusted by moving the brake lever towards or away from the disc.

Note:

To adjust the tension of the brake cables, loosen the self-locking nut **C**, adjust the cable length and then fasten **C** again.

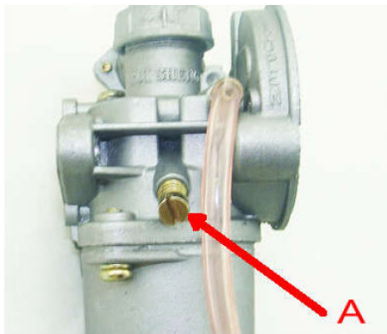

ADJUSTMENT OF IDLING SPEED

In order to perform this operation correctly, we advise you to do it when the engine is hot, connecting an electric revolution counter to the spark plug wire. Then use a screwdriver on register screw **A** to calibrate the minimum.



CAUTION!

Always release the remaining fuel from the carburetor after use every time following the below steps

1. Use a screwdriver to unscrew the drain plug at the bottom of the carburetor.
2. Release the remaining fuel.

Use a screwdriver to tighten the drain plug securely.

TROUBLESHOOTING

PROBLEM	CAUSE	REMEDY
The engine doesn't start	-Fuel system (tubes, fuel tank, valve) is blocked	Clean the system
	-No current arriving at the spark plug	Clean or replace the spark plug. If the problem persists, consult one of our Authorized Dealers
	-Engine is flooded	With gas completely open, continue trying to start engine for a few Moments. If engine still doesn't start, remove the spark plug and dry it off.
Engine misfires	-Spark plug has irregular electrode distance	Restore correct distance
	-Spark pug is dirty	Clean or replace
Engine overheats and loses power	-Silencer partially obstructed	Contact an authorized dealer
	-Exhaust clearance partially obstructed	Contact an authorized dealer
	-Mix too lean	Jet may be partially obstructed
	-Delayed ignition	Contact an authorized dealer
Weak brake	-Worn Brake pads	Contact an authorized dealer

CIRCUIT DIAGRAM FOR ELECTRIC START MODEL

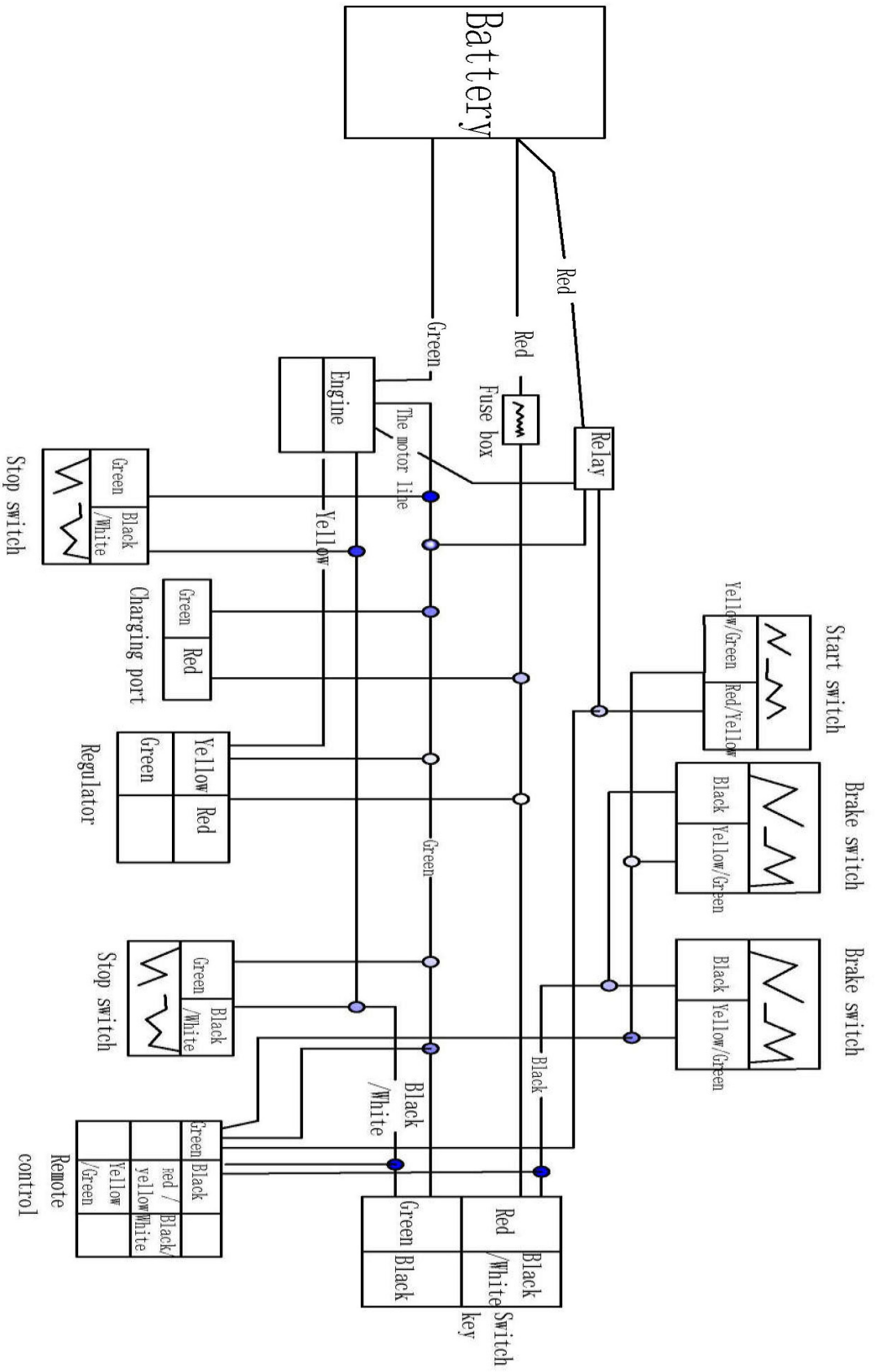

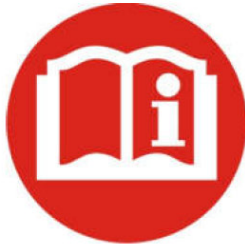

Please read the owner's manual before riding.



Never operate this vehicle if you are under age 12.



Never use the vehicle on public roads. OFF ROAD use only.



Never ride with a passenger



Always use an approved helmet and protective gear



NEVER use with drugs or alcohol



Cold tire pressure.